



Smart Halogen Downlight QBS020

QBS024 1x MAX50W-GU5.3 12V WH

QBS024 - 1 pc

Shop owners opening a new outlet or refurbishing their current installation and contractors looking for attractive propositions for their customers (small/non-chain retailers) now have the ideal solution for impactful, yet affordable accent lighting. Our Smart Halogen Downlight offers customers a choice of different shapes to suit different functions, and the professional finish lends the luminaire an air of contemporary sophistication. Thanks to its robust housing, the Smart Halogen Downlight is a long-lasting solution. Quality clips ensure ease of installation.

Product data

• General information

Product family code	QBS024 [QBS024]
Number of light sources	1 [1 pc]
Cap-base	GU5.3 [GU5.3]
Ingress protection code	IP20 [Finger-protected]
Colour	WH [White]
Flammability mark	F [For mounting on normally flammable surfaces]

• Electrical

Maximum lamp power	MAX50 [Max. 50 W]
Input voltage	12 V [12 V]

• Product Data

Order code	910403630263
------------	--------------

Full product name	QBS024 1x MAX50W-GU5.3 12V WH
Order product name	QBS024 1x MAX50W/12V-GU5.3 WH
Pieces per pack	1
Packs per outerbox	50
Bar code on pack - EAN1	6923828687496
Bar code on outerbox - EAN3	6923828699048
Logistic code(s) - 12NC	910403630263
Net weight per piece	1.010 kg



PHILIPS

Dimensional drawing

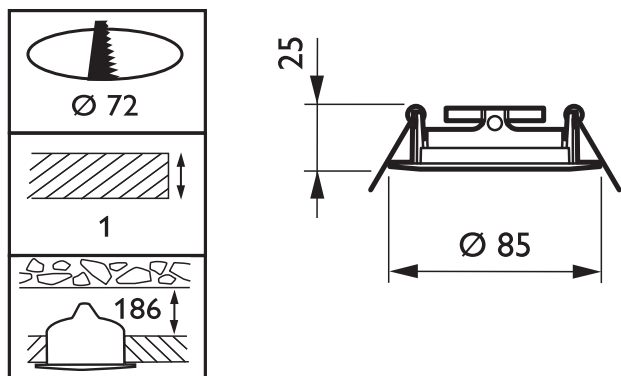

QBS024 1x MAX50W-GU5.3 12V WH



© 2014 Koninklijke Philips N.V. (Royal Philips)
All rights reserved.

Specifications are subject to change without notice. Trademarks are the property of Koninklijke Philips N.V. (Royal Philips) or their respective owners.

www.philips.com/lighting

2014, February 1
data subject to change