



# Smart Halogen Downlight QBS020

QBS026 1x MAX50W-GU5.3 12V WH

QBS026 - 1 pc

Shop owners opening a new outlet or refurbishing their current installation and contractors looking for attractive propositions for their customers (small/non-chain retailers) now have the ideal solution for impactful, yet affordable accent lighting. Our Smart Halogen Downlight offers customers a choice of different shapes to suit different functions, and the professional finish lends the luminaire an air of contemporary sophistication. Thanks to its robust housing, the Smart Halogen Downlight is a long-lasting solution. Quality clips ensure ease of installation.

## Product data

### • General information

Product family code	QBS026 [QBS026]
Number of light sources	1 [1 pc]
Cap-base	GU5.3 [GU5.3]
Ingress protection code	IP20 [Finger-protected]
Colour	WH [White]
Flammability mark	F [For mounting on normally flammable surfaces]

### • Electrical

Maximum lamp power	MAX50 [Max. 50 W]
Input voltage	12 V [12 V]

### • Product Data

Order code	910403630267
------------	--------------

Full product name	QBS026 1x MAX50W-GU5.3 12V WH
Order product name	QBS026 1x MAX50W/12V-GU5.3 WH
Pieces per pack	1
Packs per outerbox	50
Bar code on pack - EAN1	6923828687533
Bar code on outerbox - EAN3	6923828699086
Logistic code(s) - 12NC	910403630267
Net weight per piece	0.900 kg



# PHILIPS

Dimensional drawing

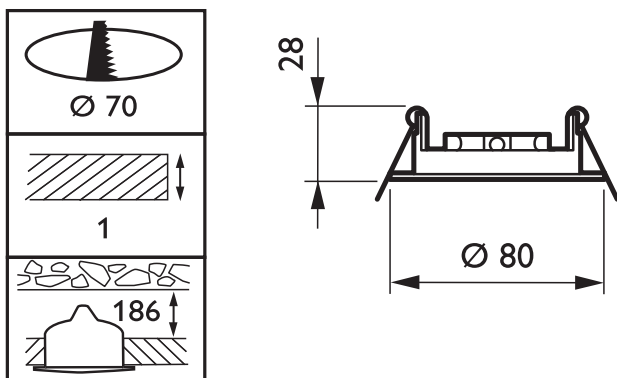

QBS026 1x MAX50W-GU5.3 12V WH



© 2014 Koninklijke Philips N.V. (Royal Philips)  
All rights reserved.

Specifications are subject to change without notice. Trademarks are the property of Koninklijke Philips N.V. (Royal Philips) or their respective owners.

[www.philips.com/lighting](http://www.philips.com/lighting)

2014, February 1  
data subject to change